

Model Name: F44AB

www.adt.link

Product Name: M.2 NVMe to PCIe x16 extender

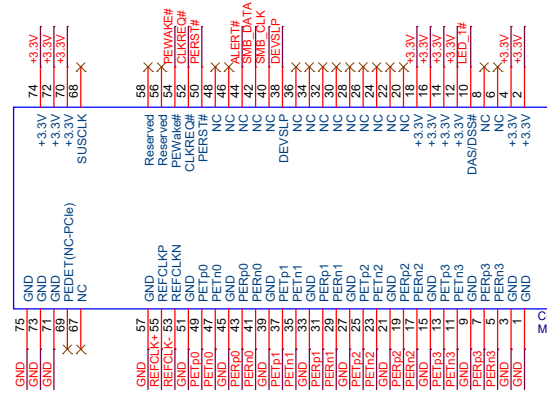

PCB model: F4B V1.1

CN1 M.2 Socket 3 Key (M)

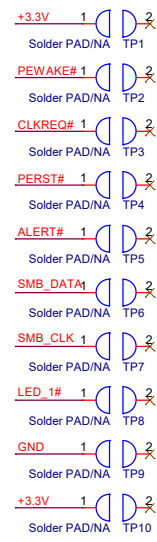
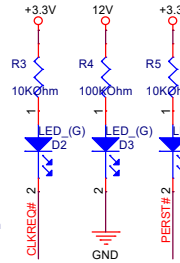
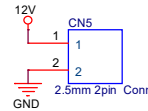
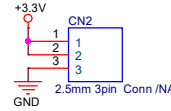

External Power Supply DCDC 12V to 3V3 /3A

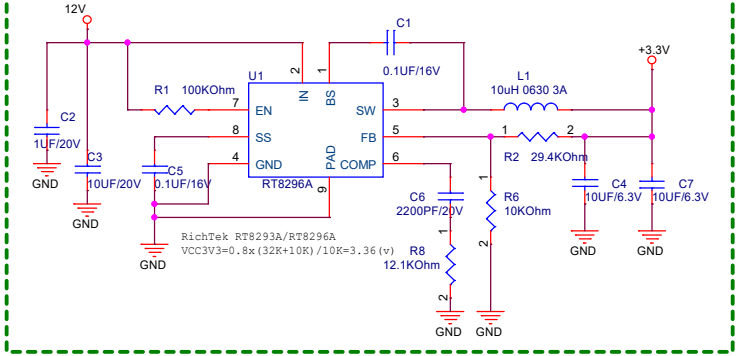

Revision History

Date	Version	Description
2024Jan29	1.0	First Release

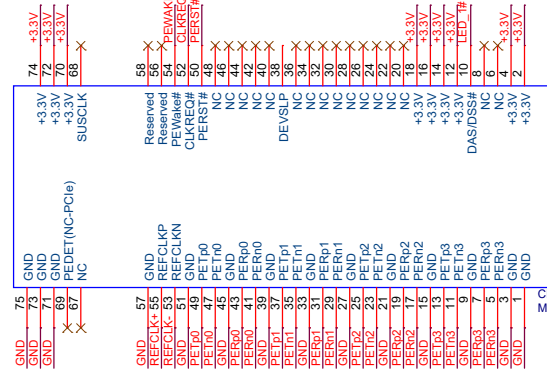
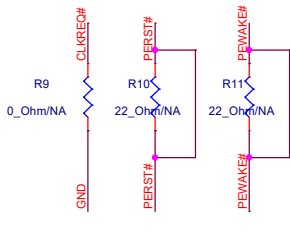
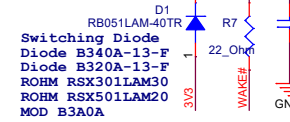

PCB model: F4A V1.1

CN7 M.2 Gold-finger Key (M)

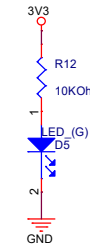
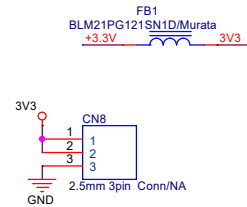

Revision History

Date	Version	Description
2024Mar27	1.0	First Release
2024Apr18	1.1	Delete CN4,CN9