

Model Name: ADT-M4314

www.adt.link

Revision History

Product Name: M.2 NVMe to PCIe x16 extender

M34 V1.0

Date	Version	Description
2024Apr21	1.0	First Release

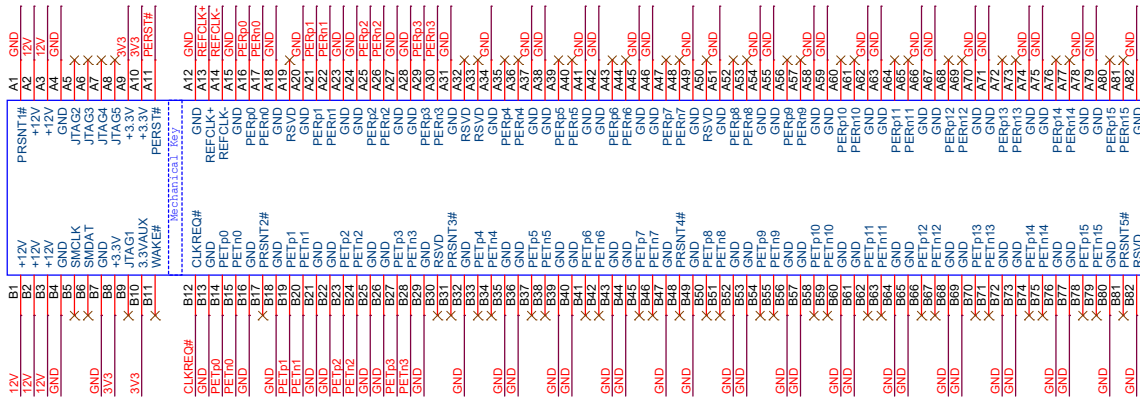

CN1  
PCIe-16X-finger

Switching Diode  
Diode 1N4001/DO-214AC  
ONSEMI SS14/SMA  
0\_0hm

J1 12P\_Cable

J2 24P\_Cable

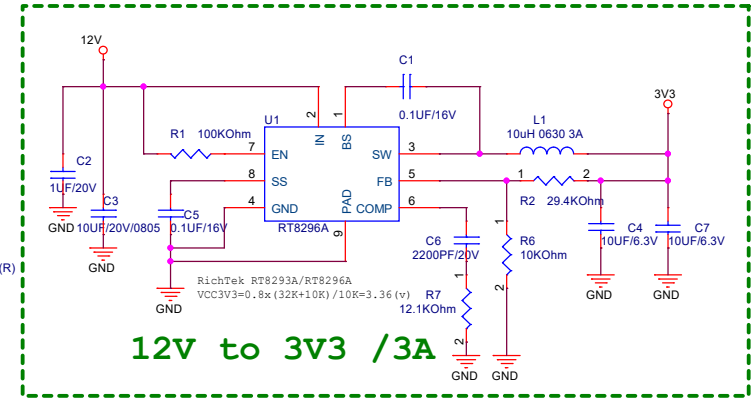
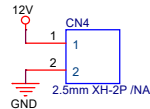
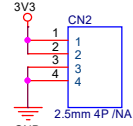

12V to 3V3 /3A

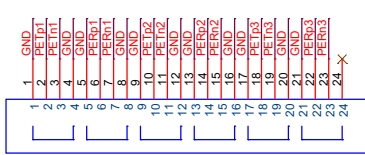
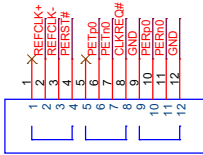

J3 12P\_Cable

J4 24P\_Cable

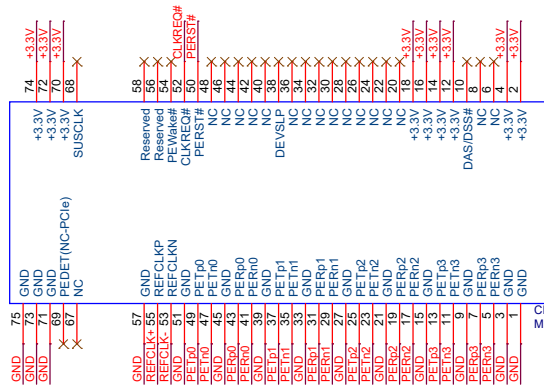

CN5  
M.2 Socket 3 Key (M)

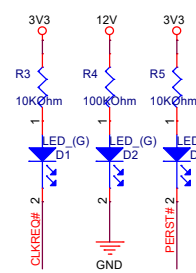
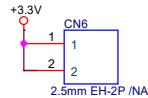

Revision History

Date	Version	Description
2024Apr21	1.0	First Release

M41 V1.0